

It

Pleat

Pleat

It



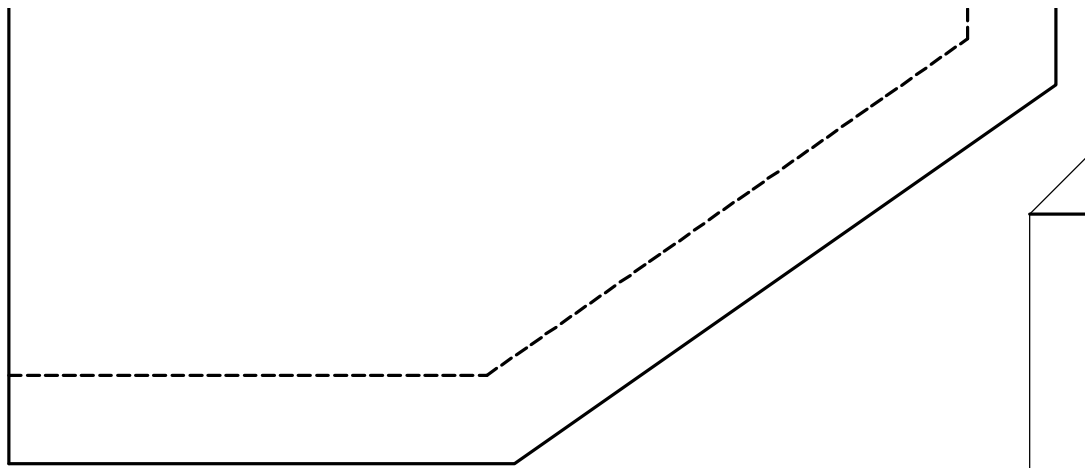
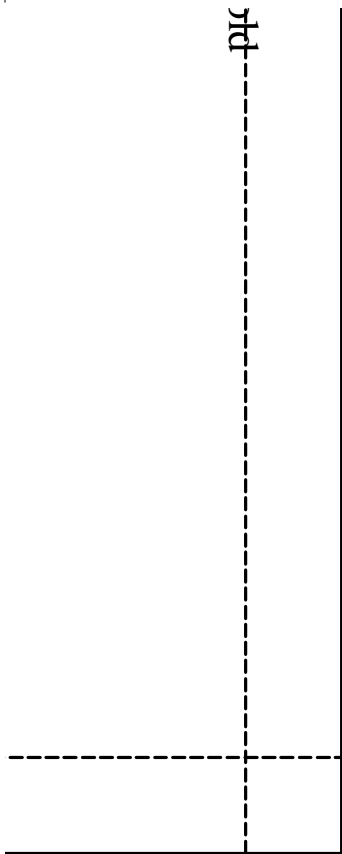

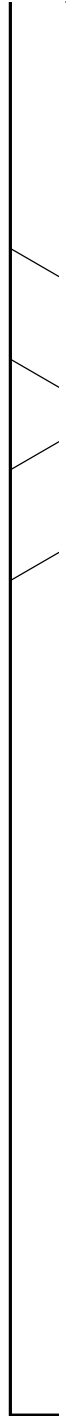

# up Reinforcement

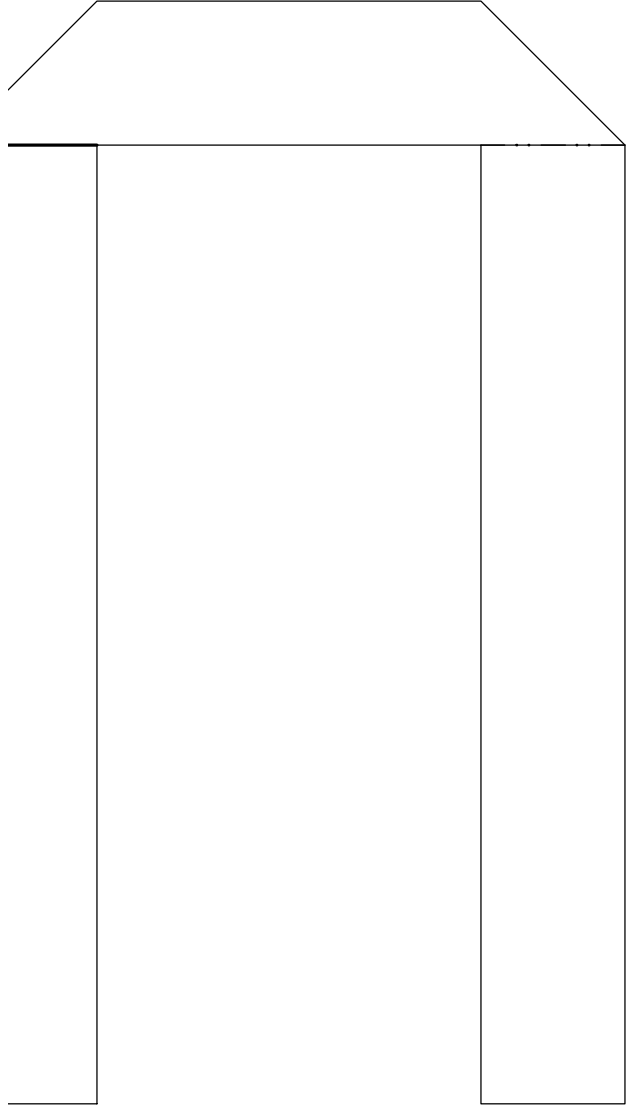
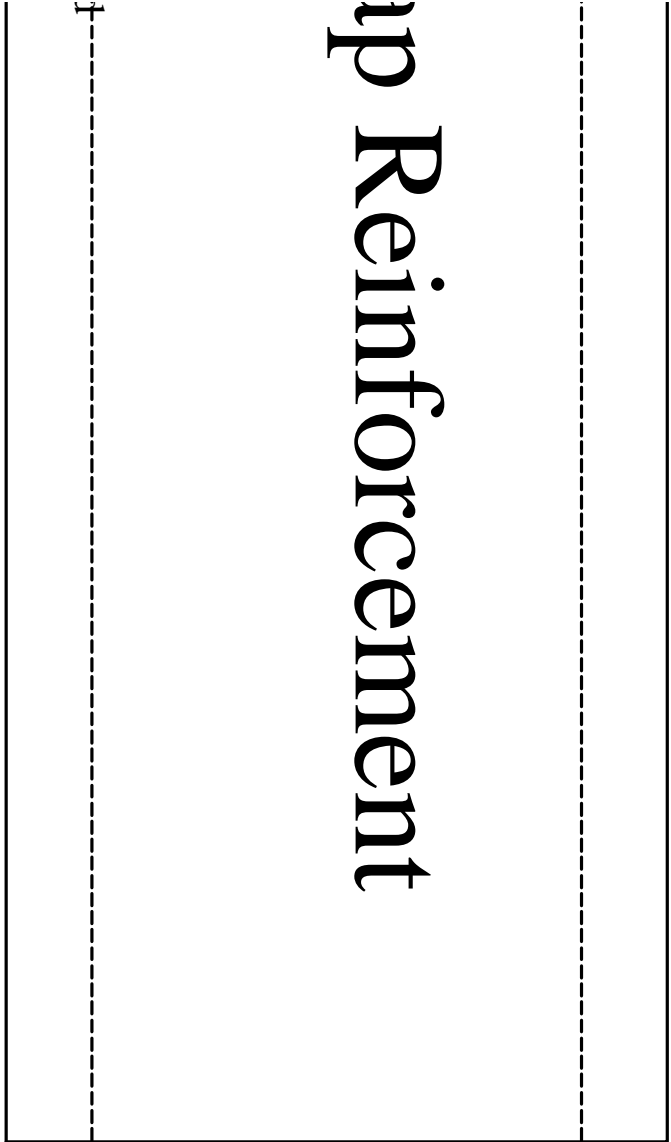

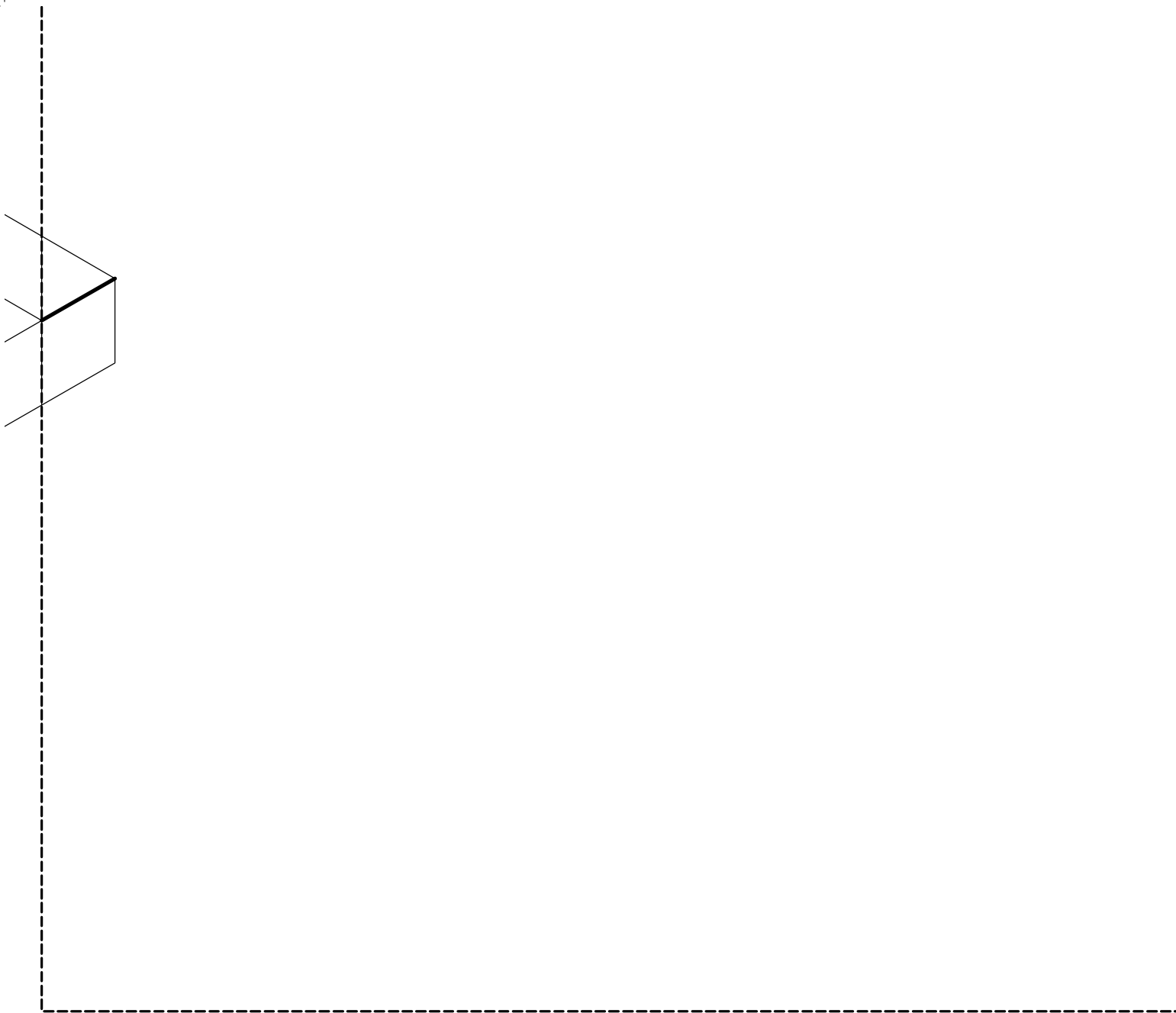

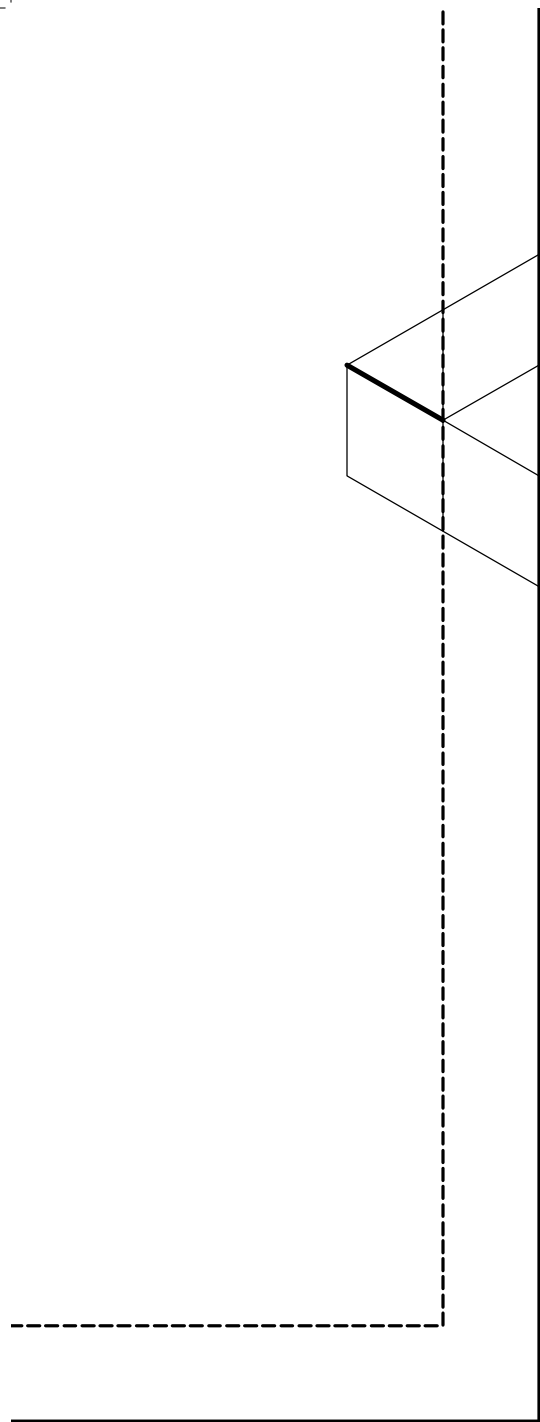

R1 C5

Strap

Upper Pocke

R2 C1

Pleat

Pleat

Fe

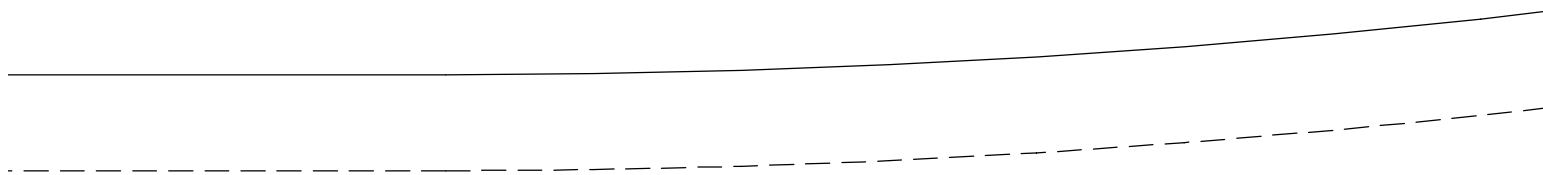

# Shoulder

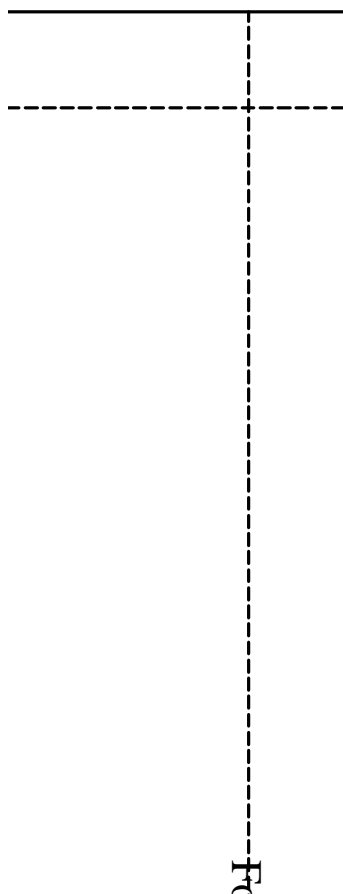
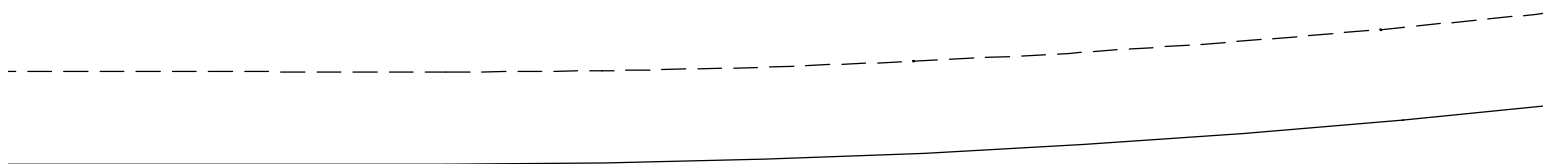

Fr

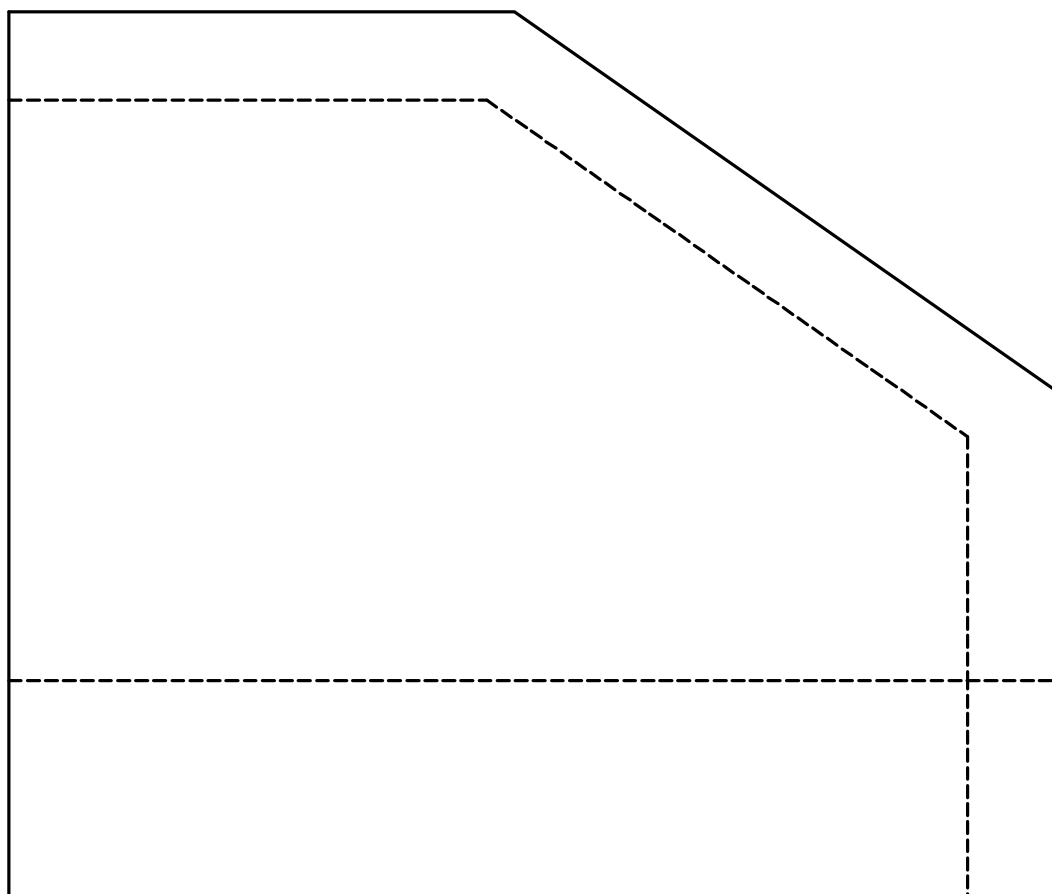

R2 C2





# Shoulder Straps

Sew to back then fold

R2 C3

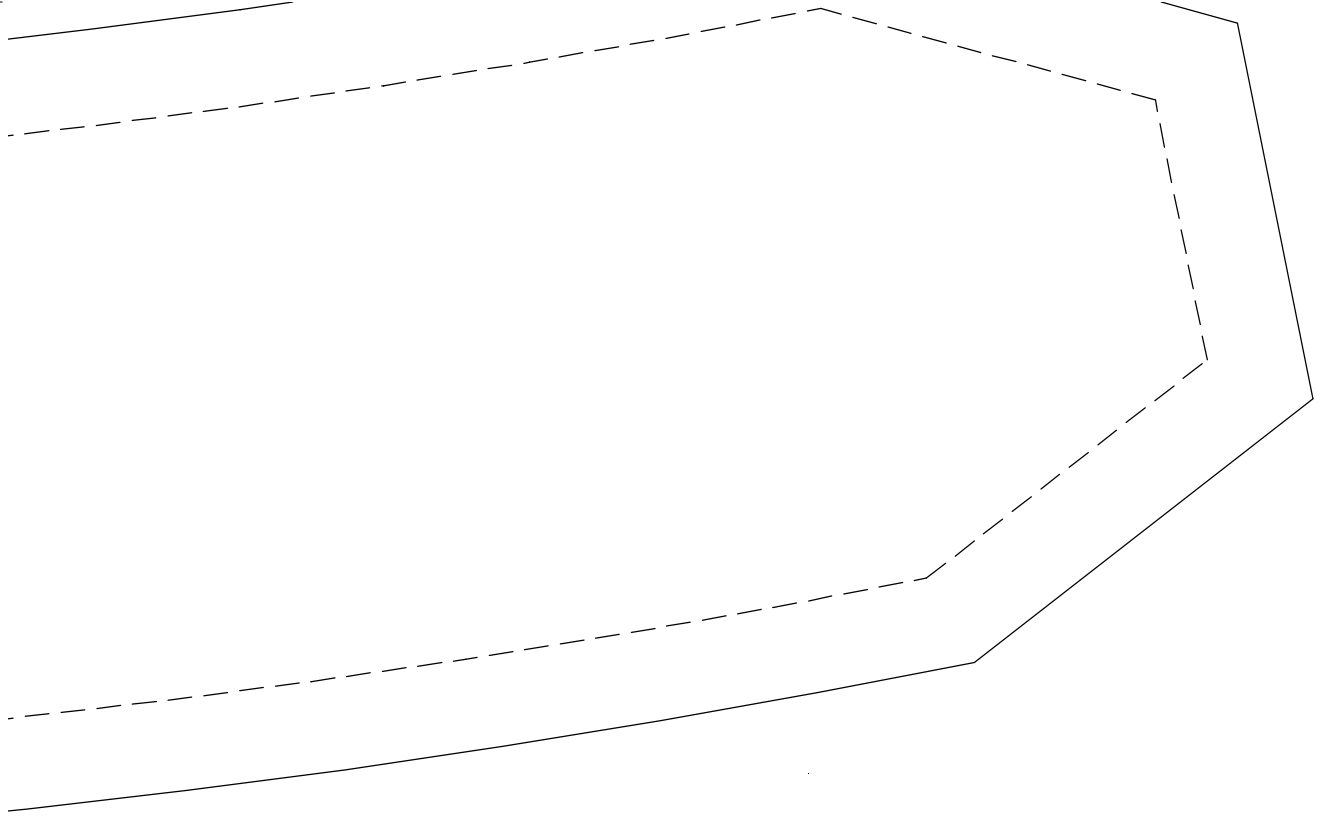
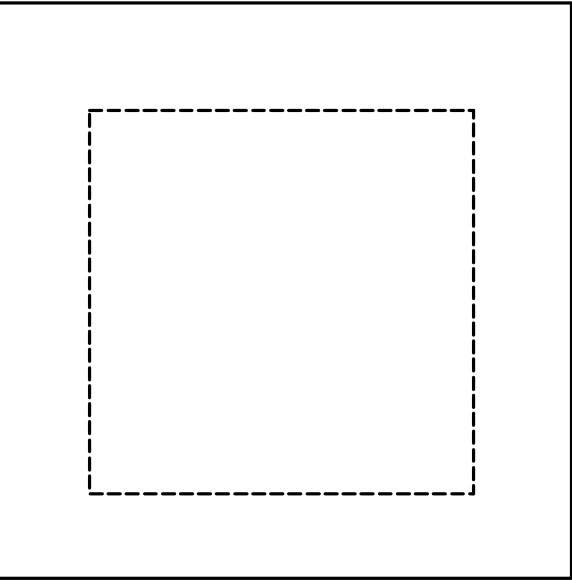



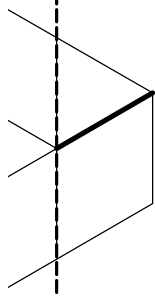
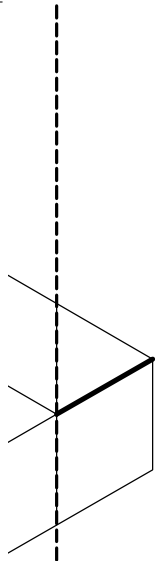

Front





R2 C5



# Wer Pocket

Pleat

Fold

Fold

07

Pleat

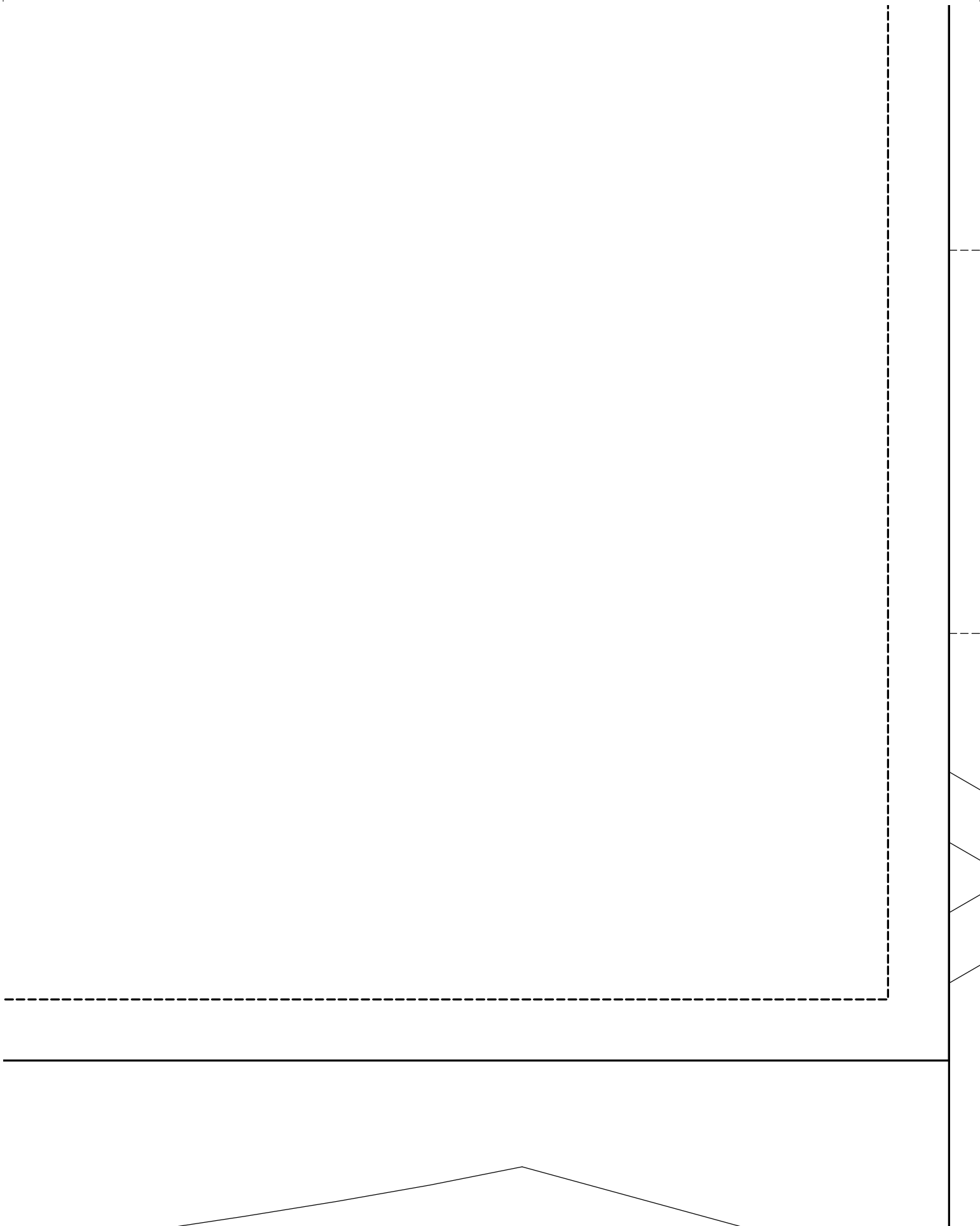

R3 C3



# Flat Bottom

## Front to Bottom Radii

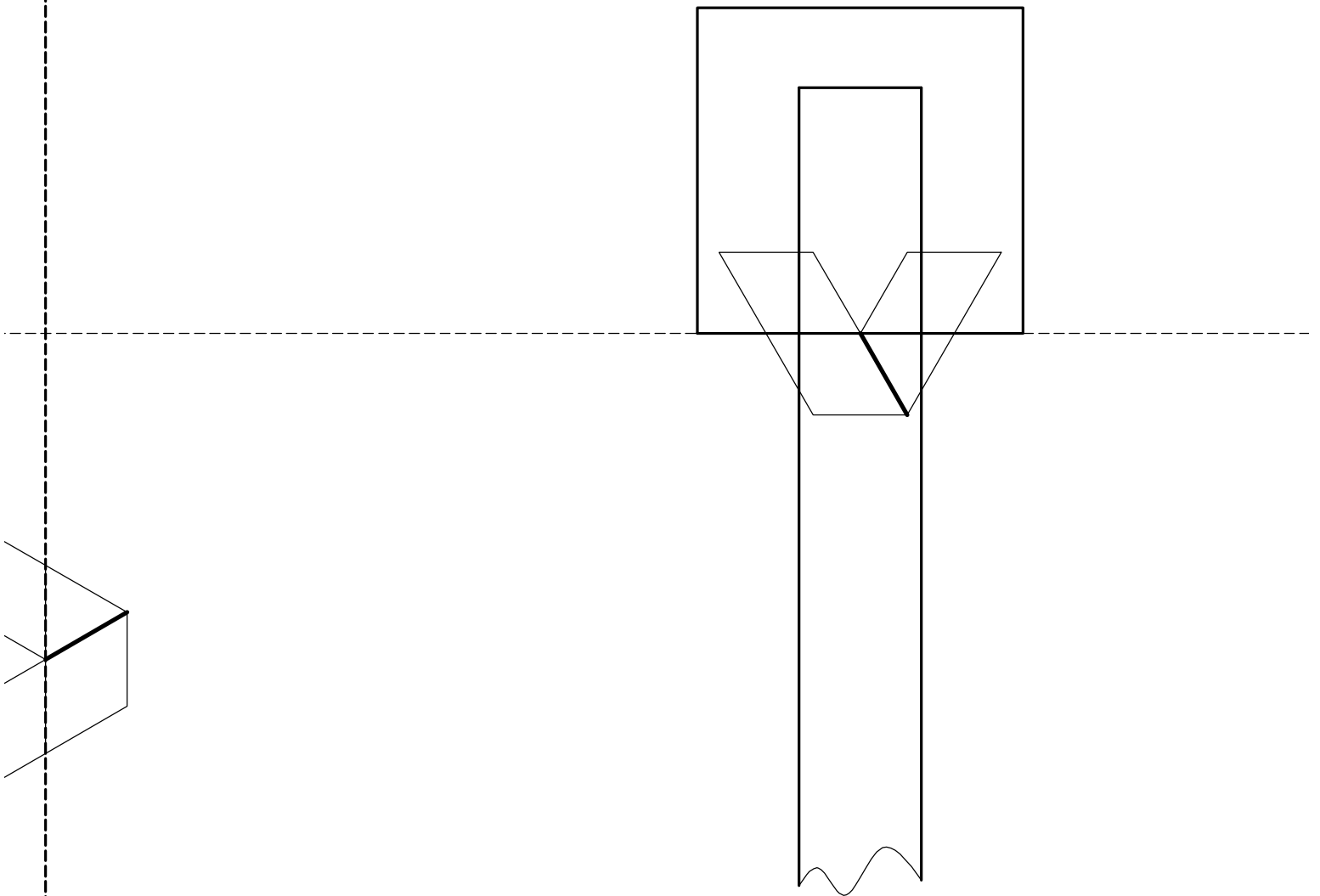



JS

i

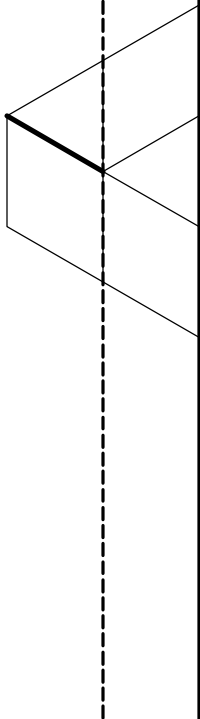

R3 C5

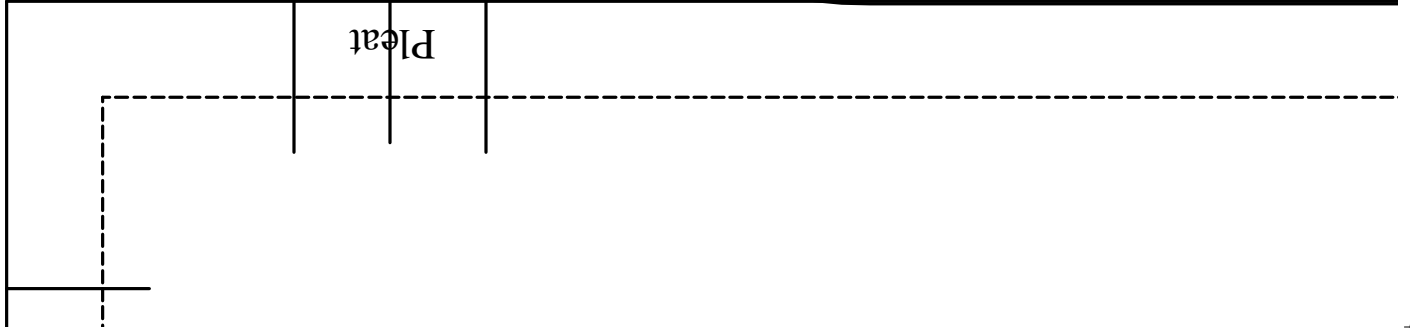
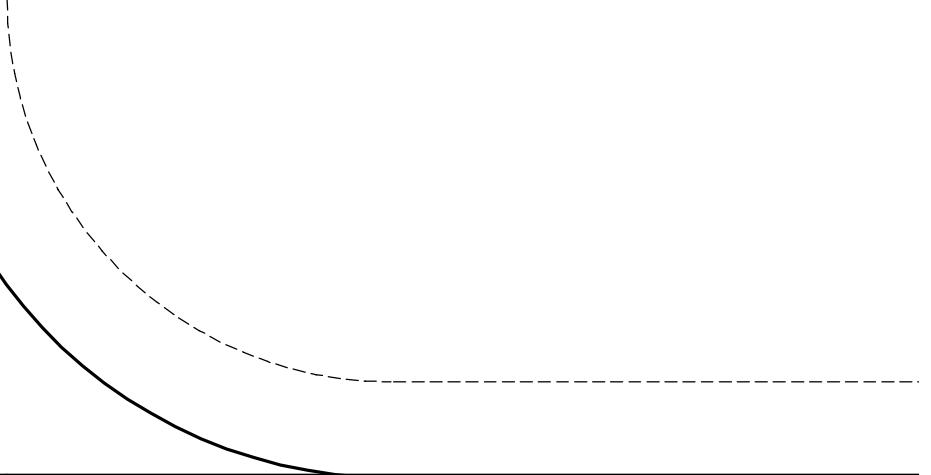
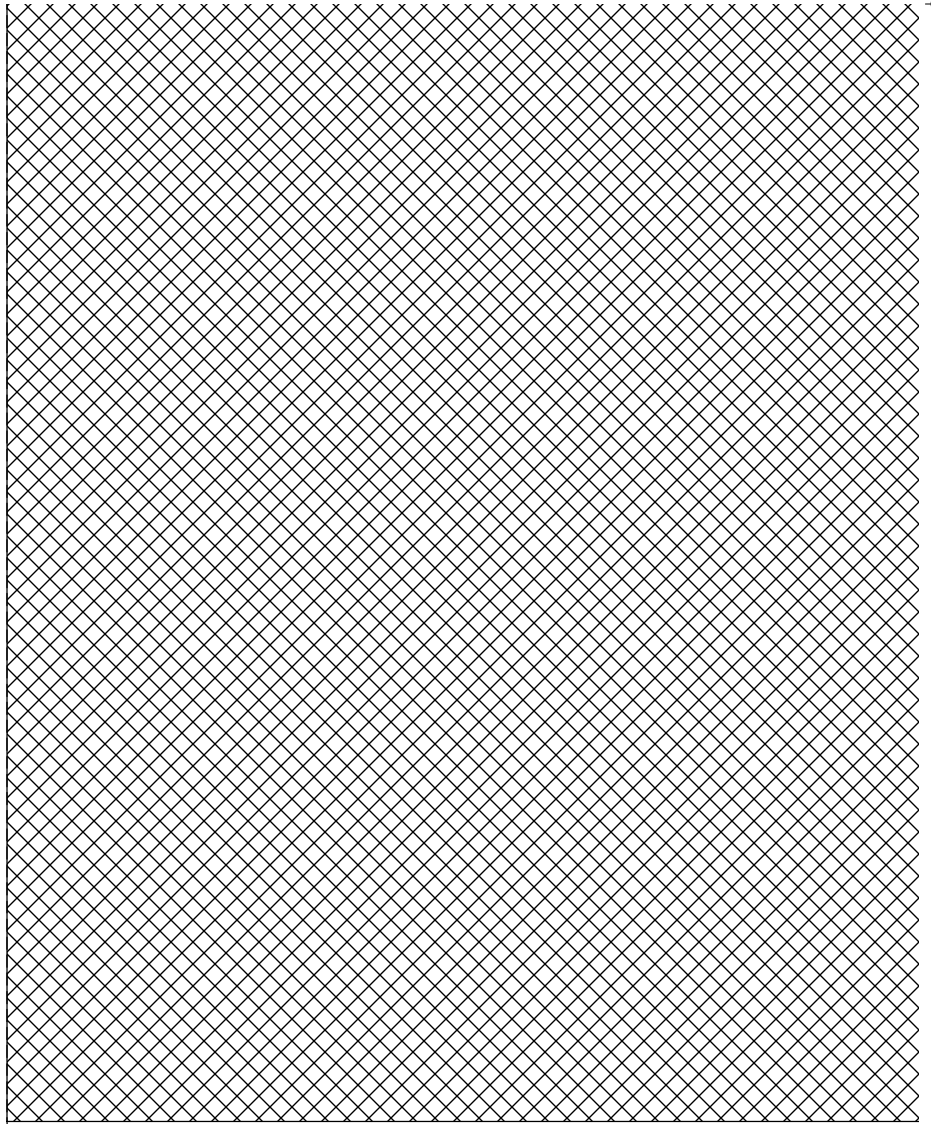

Plat





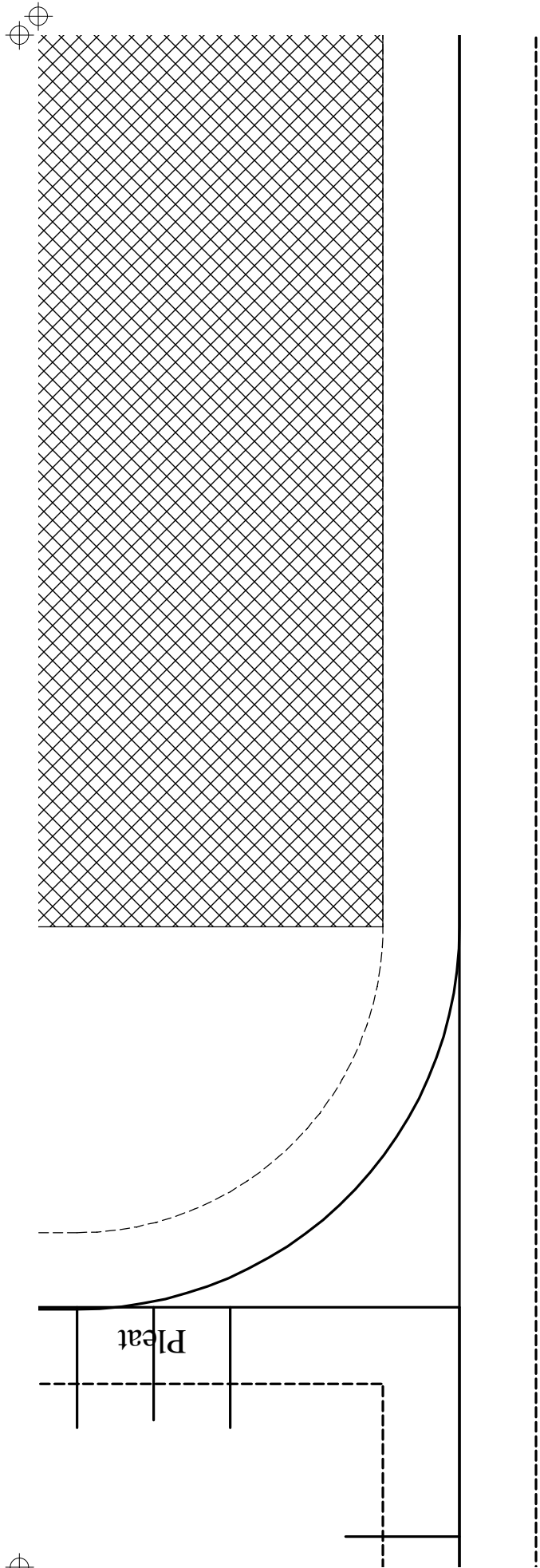

R4 C2



R4 C3

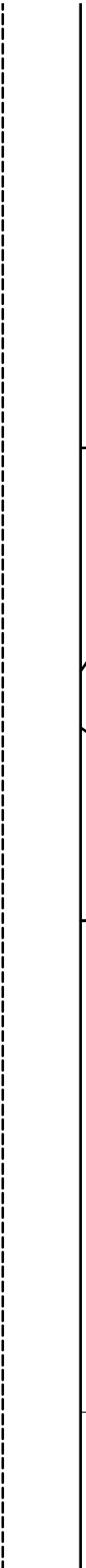

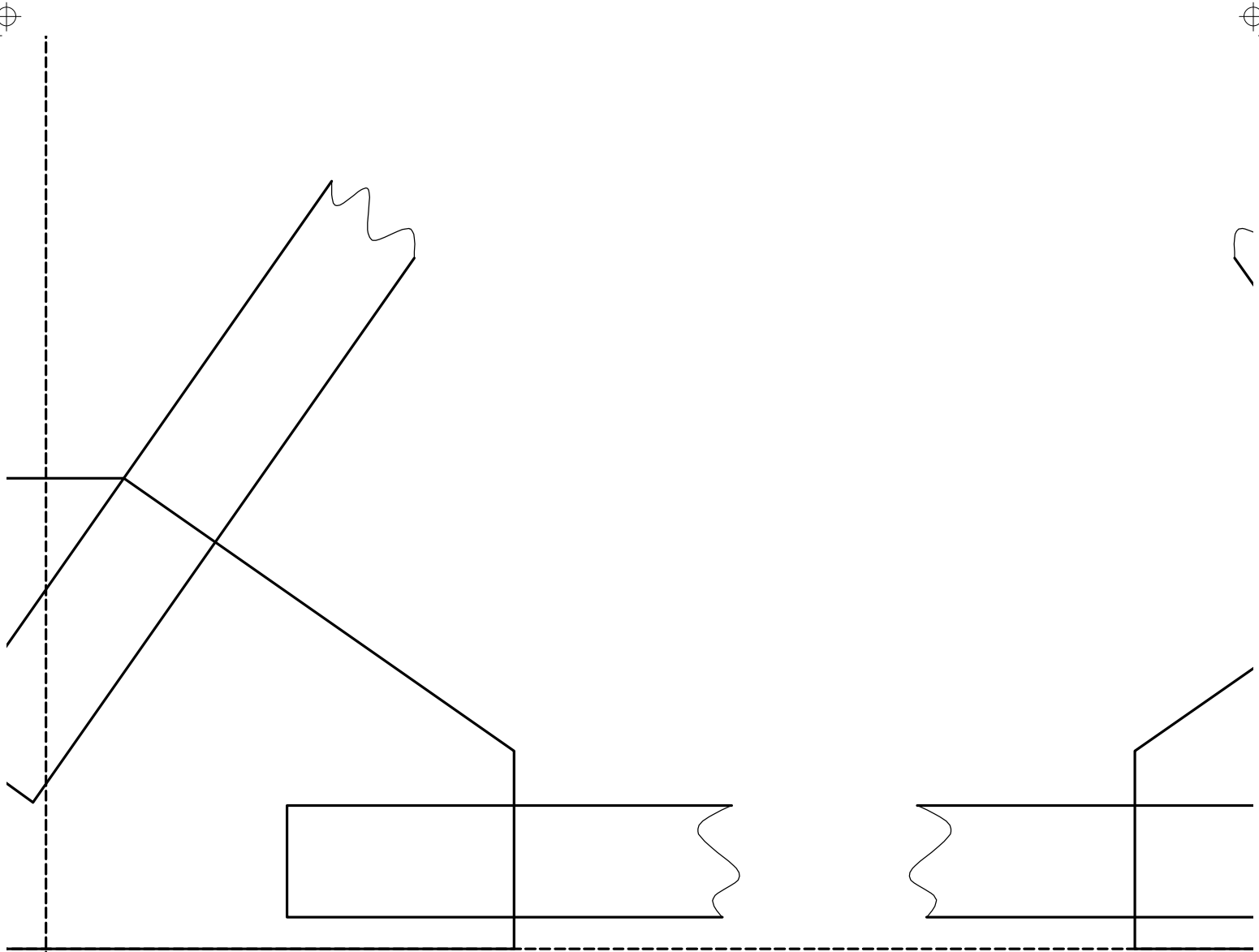

# Back to Bottom Radii

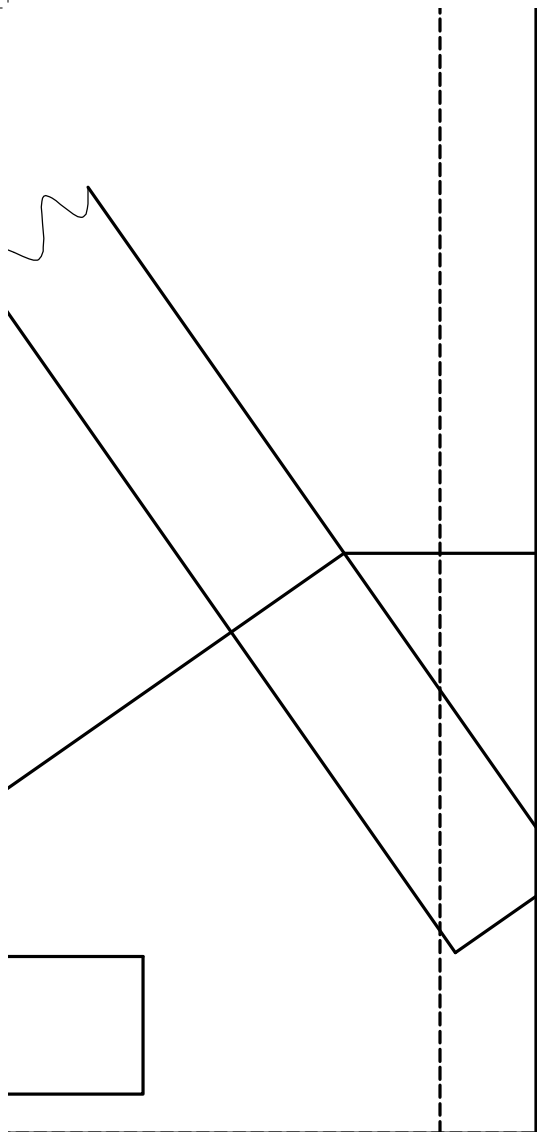

US



R4 C5

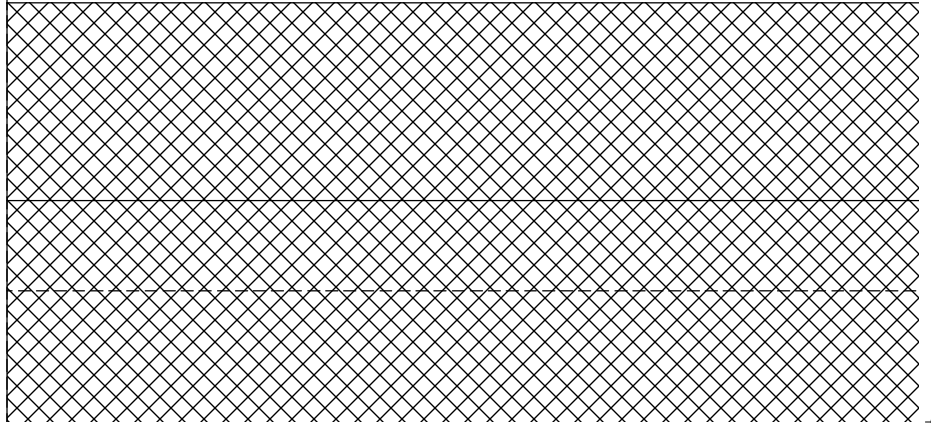
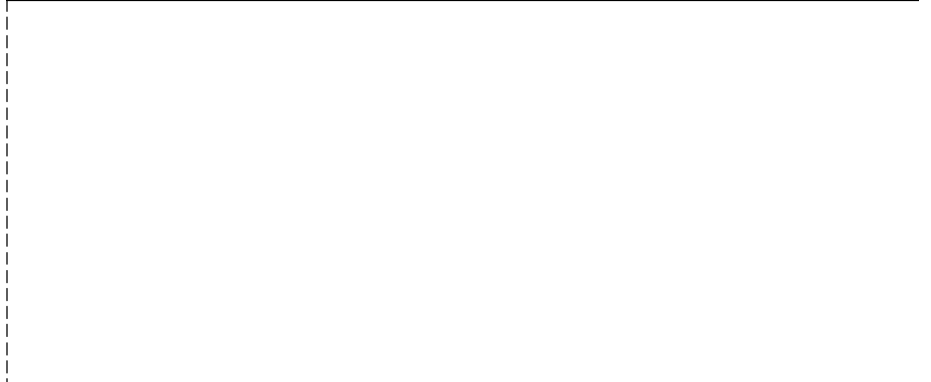
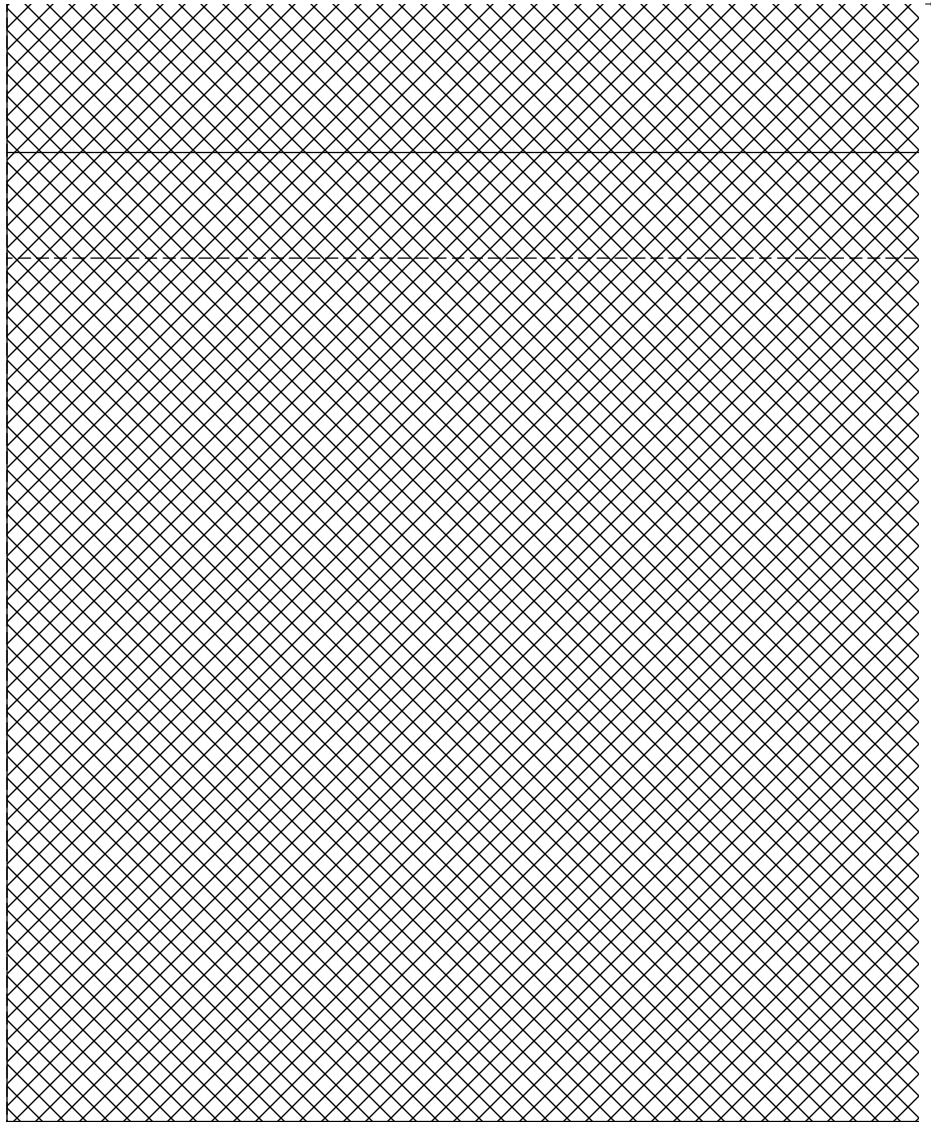

R5 C1



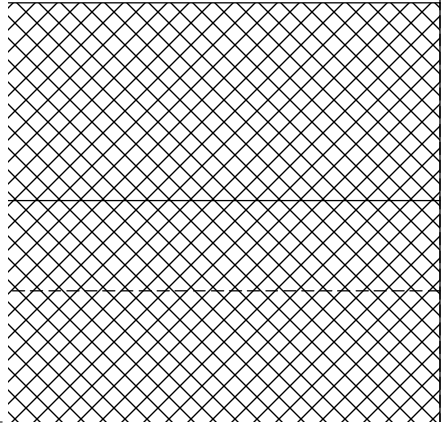
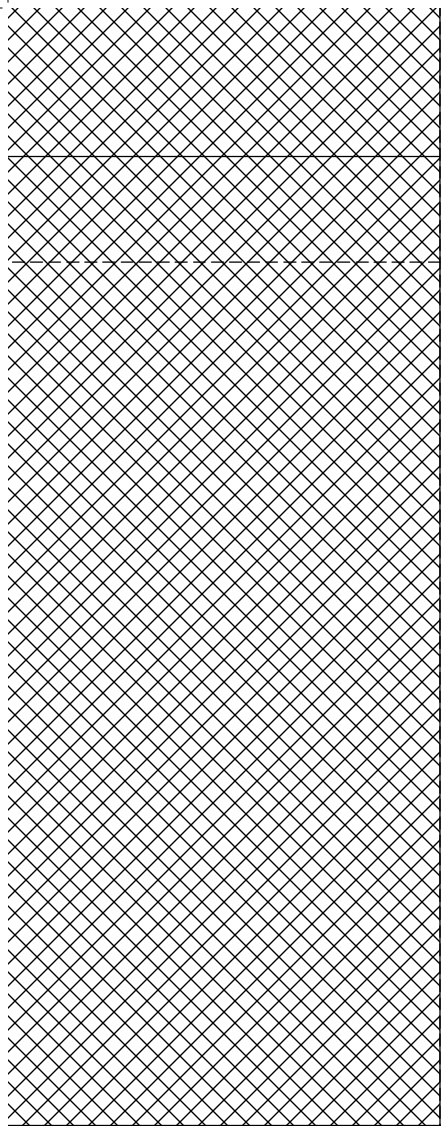

R5 C2



R5 C3









R5 C5





R6 C1



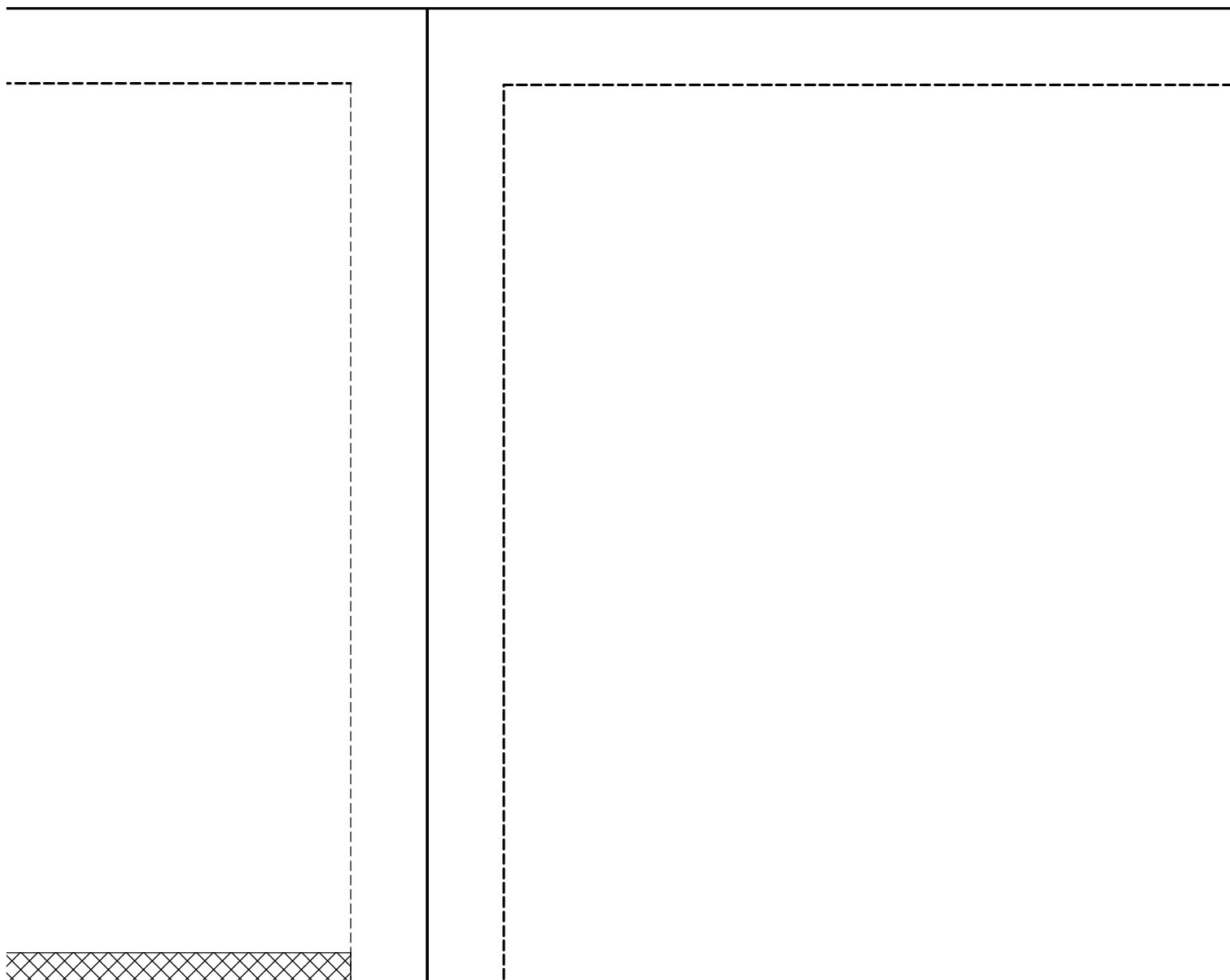

R6 C2



R6 C3

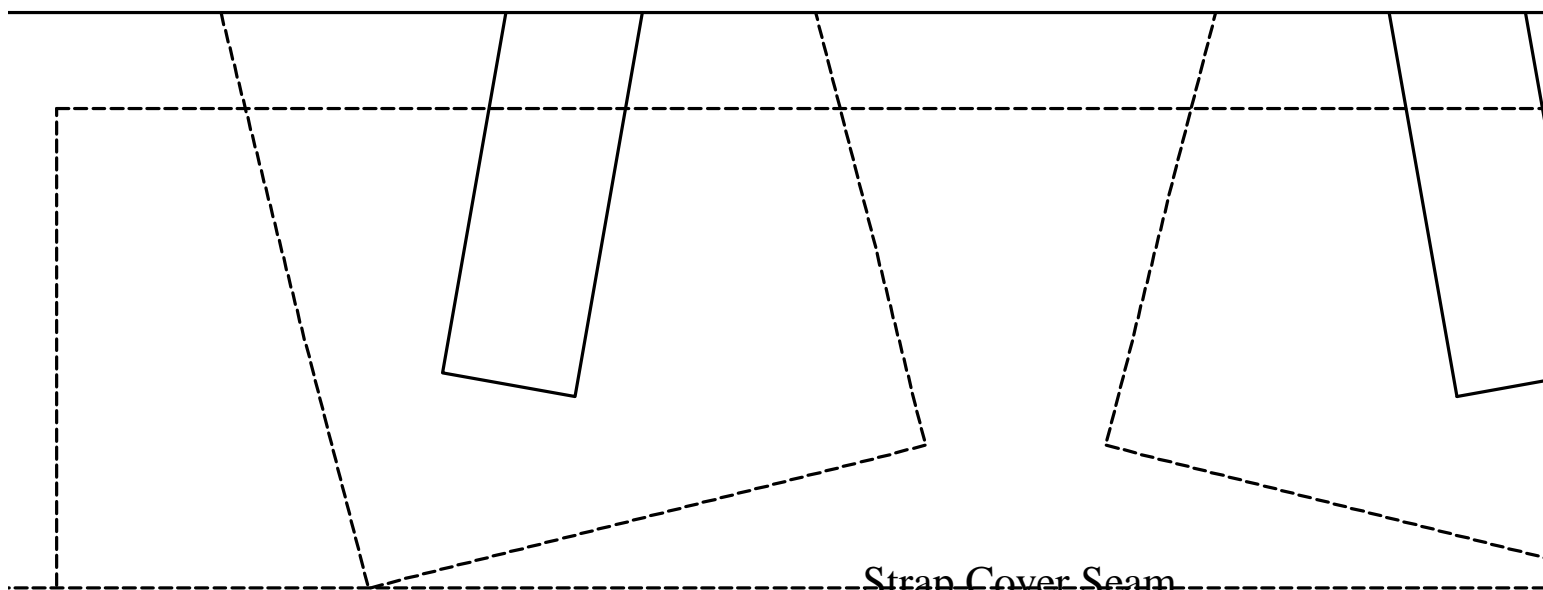

Strap Cover Seam

# Back



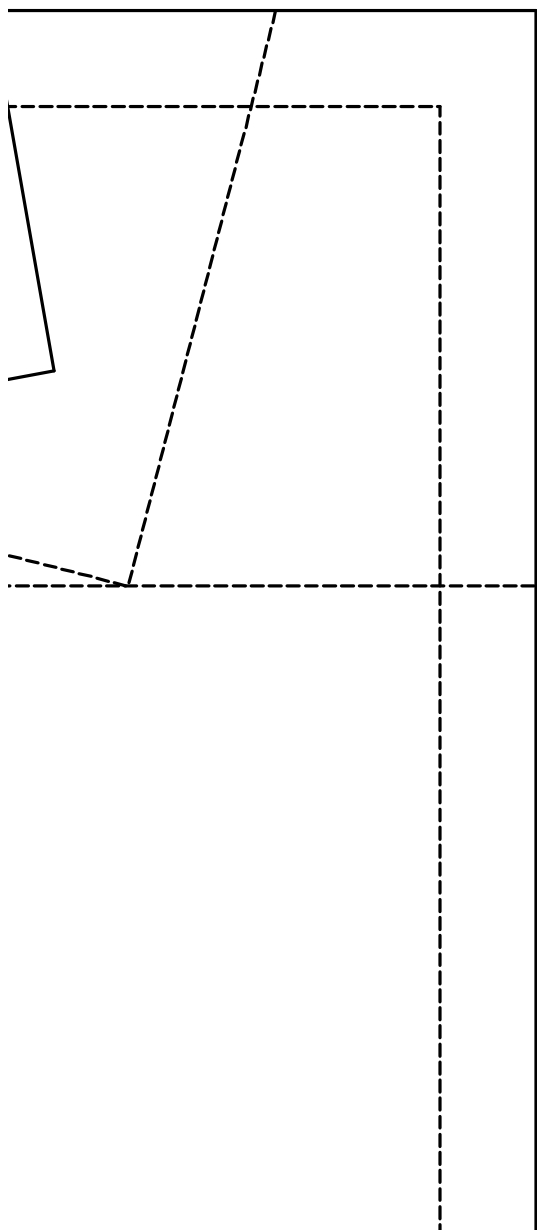

R6 C5

